

## H42C Headwall Range

Up to 750mm Pipework  
1120mm - 2340mm Backwall Height

A one piece reinforced concrete headwall available with five standard backwall heights. Particularly suitable for steep embankments. Due to the relatively narrow footprint of the unit (back to front) it is advisable to fit suitable brackets to attach ground anchors. The largest unit can accommodate PCC pipes up to 750mm ID and Plastic pipes up to 750mm ID. Stainless steel sockets are provided for the attachment of gratings. Galvanised Mild steel angle can be fitted to the side walls in order to fit stop logs and the backwall can be extended horizontally through the fitting of side wall extensions if required.



H42CA

H42CB

H42CC



H42CD

H42CE

Headwall	Max Pipe Opening Plastic/C/ware	Max Pipe Opening PCC	A	B	Approx Weight kg
H42CA	600	600	1375	1120	810
H42CB	750	750	1375	1425	1070
H42CC	750	750	1375	1730	1230
H42CD	750	750	1375	2035	1390
H42CE	750	750	1375	2340	1550

Optional Kee Klamp handrail

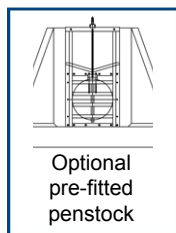
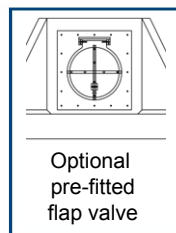
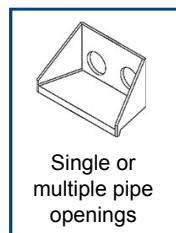
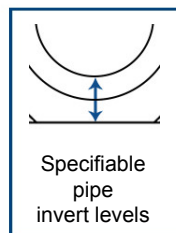
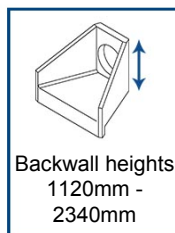
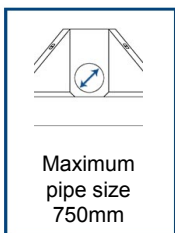
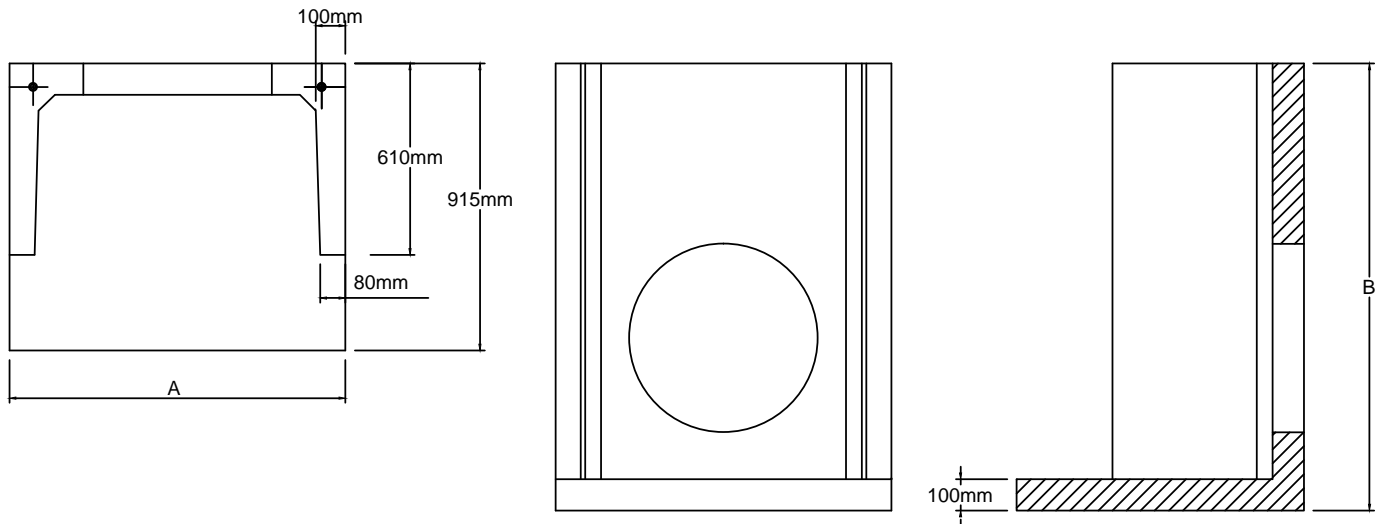



## Installation Guide

Once installed correctly the ground pressure of a headwall is low (approximately 13.5kn/m<sup>2</sup>) Althon suggest a minimum sub base of 200mm dry mix concrete to give a flat and level foundation to sit the headwall onto. The sub base must extend a minimum of 800mm in front of the headwall when at the head of a culvert and 300mm behind to give a total depth of footing of 2 meters to the appropriate width of the headwall.

1. Ensure that the pipe is fully fitted leaving either the first (or last) section of pipe free from backfill in order to attach to the headwall
2. Dig out the bank of the watercourse to take the size of the headwall making sure that the headwall will not protrude into the path of the water flow
3. If the structure is going to have side walls fitted then dig a trench of suitable size to take the panel at right angles to the pipe line with the front face of the trench to be 350mm forward of the end of the pipe
4. Lay a minimum (dependant on ground conditions) of 200mm thick bed of dry mix concrete as a flat and level foundation to rest the headwall on.
  - Some concrete will also be needed in the trenches to take the wall panels. This should be at the same top level as the main headwall foundation
5. Prior to lifting and positioning the headwall attachments such as gratings and water control gear should be removed
  - If using wall panels galvanised slides must be fitted to the unit prior to commencing the lifting operation as they will assist with locating the wall panels correctly
6. Lift the headwall into position using 2no RD20 Premium swivel lifting eyes, long chains (minimum of 2000mm long) and suitable machinery. Before carrying out the lifting operation all relevant personnel involved should read the installation and lifting guide in this document and a detailed lift plan and risk assessment should be completed by a competent person
  - The RD20 threaded sockets for lifting are located in the top of the wing-wall
  - Placing a shim at the bottom of the pipe will assist with centring it in position
  - If attachments such as water control gear or gratings are to be fitted to the headwall – the pipe must be fitted flush with the inside of the back wall
  - If there are no attachments to be fitted Althon recommend fitting the headwall so that the pipe protrudes 50mm through the back wall
7. When side walls are supplied use the same RD20 Premium swivel lifting eye's to lift and position the side walls in the galvanised channels which face away from the headwall and mastic seal the panels into the channel
  - When two panels are provided to achieve a certain height we recommend using mastic seal between the two panels
8. If an extension is to be fitted, repeat procedures 6 & 7 to position them in place with an appropriate mastic / resin or mortar bedding between the headwall and extension. Fit any bolts or bracketing that has been supplied in order to link the two components together



- To prevent bolts binding copper slip must be applied to the thread of all bolts
- Do not exceed a torque setting of 40Nmm<sup>2</sup> when tightening bolts

9. When satisfied with the position backfill in front and under the headwall toe with mass concrete

10. Backfill around the pipe with either mass concrete or well-compacted impervious clay. If concrete has been used around the pipe then proceed with soil backfilling to the top level of the structure ensuring good compaction as you go

11. Backfill around the wing walls with either mass concrete or well-compacted impervious clay. If concrete has been used around the wall panels then proceed with soil backfilling to the top level of the structure ensuring good compaction as you go

12. Dependent upon soil conditions and specific site requirements Althon recommend backfilling around wing walls with well compacted impervious clay

13. Use an appropriate mortar or resin fill in the gap between the pipe and headwall around the opening in the back wall of the headwall

14. For fitting gratings, catwalks and other fabricated metal components:-

- Fit catwalks using 2no M16 stainless steel bolts
- Fit the stop log boards to the required height of retained water
- If using wooden stop log boards hold in place with small wooden wedges to hold the board against the back face of the galvanised channel and prevent them from floating
- Position the grating using appropriate lifting equipment
- Use the correct size and length of stainless steel bolts with washers to fix gratings to the threaded fixing sockets cast into headwalls
- To prevent bolts binding in threaded fixing sockets copper slip must be applied to the thread of all bolts
- Do not exceed a torque setting of 40Nmm<sup>2</sup> when tightening bolts

15. For fitting water control gear (i.e. Flap Vales & Penstocks):-

- Apply foam seal or mastic sealant to the back plate of the water control gear to ensure a watertight seal between the headwall
- Position the water control gear using appropriate lifting equipment
- Use the correct size and length of stainless steel bolts with washers to fix control gear to the threaded fixing sockets cast into headwalls
- To prevent bolts binding in threaded fixing sockets copper slip must be applied to the thread of all bolts
- Do not exceed a torque setting of 40Nmm<sup>2</sup> when tightening bolts. Overtightening bolts may distort the back-plate thus preventing the valve from sealing correctly

PLEASE NOTE: When the installation is complete and there is a head of water against the boards the water will try to find a way around the structure wherever possible, such as under the unit and around the outside of the pipe. This must be taken into consideration when siting and backfilling the unit and pipe.