



N27 Headwall Range

Up to 1200mm Pipework
1300mm - 1900mm Backwall Height

300 and 500mm Thick Toe

Althon 'N' range of precast headwalls are particularly suited for installation where you have steep banks or little room from back to front.

Althon precast concrete outfalls offer a cost-effective alternative to in-situ structures for connecting pipework discharging into open watercourses.

Manufactured to the same standards as our 'Sewers for Adoption' headwalls these units can be used on Section 104 Agreements where the sewers are to be adopted once completed by the local water company.

There are three sizes of the 'N' concrete outfall models available, catering for pipe sizes up to and including 1500mm. Each size of 'N' model comes with three depths of toe and five back wall heights with a wing wall profile of approx. 1:3 to suit most applications.

Althon 'N' precast concrete outfalls are cast to suit the diameter and type of pipe being used and can be provided with fixings cast in at the time of manufacture to accommodate gratings, trash screens, flap valves, penstocks, ladders, Kee Klamp® handrails and flow and depth monitoring equipment.

Our 'N' outfall range is available with toe extensions either 300 or 500mm thick with depths ranging from 500 to 1000mm.

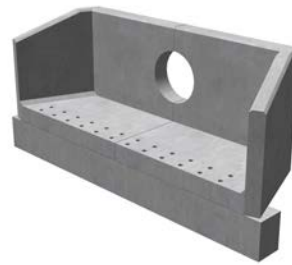

N27A
1300mm Backwall



N27B
1450mm Backwall



N27C
1600mm Backwall



N27D
1750mm Backwall



N27E
1900mm Backwall

Optional Kee Klamp handrail

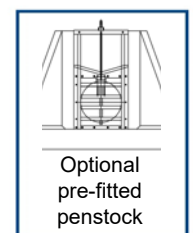
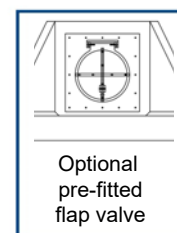
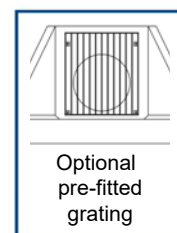
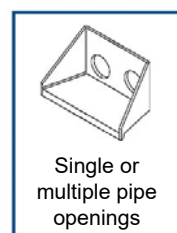
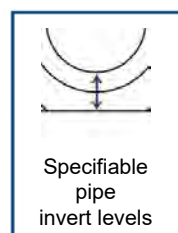
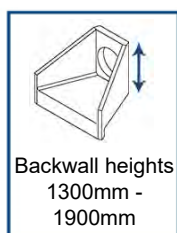
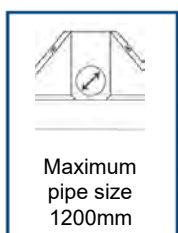
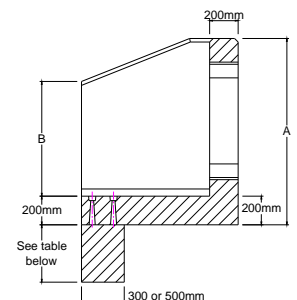
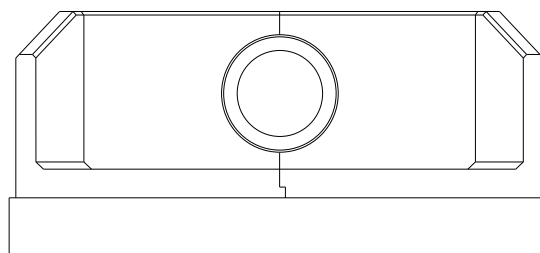
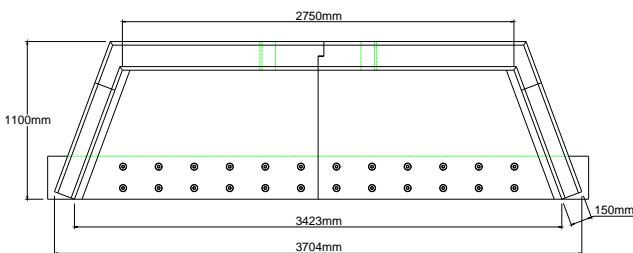



N27 Headwall Range

Up to 1200mm Pipework
1300mm - 1900mm Backwall Height

300mm Thick Toe

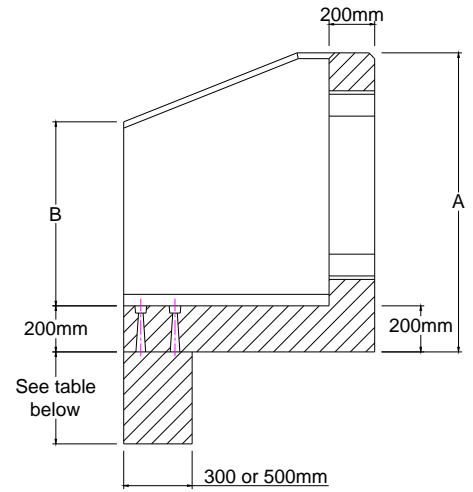

Headwall Ref	Back Wall Height A	Front Wall Height B	Weight	Weight with Toe (300mm Thick)			Max Pipe Opening	Max Pipe Opening	Max Pipe Opening	Max Pipe Opening	Max Pipe Opening	Max Pipe Opening
				500mm	750mm	1000mm						
							TW / Clay	Concrete	TW / Clay	Concrete	TW / Clay	Concrete
	mm	mm	kg	kg	kg	kg	mm	mm	mm	mm	mm	mm
N27A	1300	800	3990	5358	6042	6726	750	825	750	675	600	600
N27B	1450	950	4305	5673	6357	7041	900	900	900	825	750	750
N27C	1600	1100	4620	5988	6672	7356	1050	1050	1050	900	900	900
N27D	1750	1250	4935	6303	6987	7671	1200	1200	1200	1050	1050	1050
N27E	1900	1400	5255	6623	7307	7991	1200	1350	1200	1200	1200	1050

500mm Thick Toe

Headwall Ref	Back Wall Height A	Front Wall Height B	Weight	Weight with Toe (500mm Thick)			Max Pipe Opening	Max Pipe Opening	Max Pipe Opening	Max Pipe Opening	Max Pipe Opening	Max Pipe Opening
				500mm	750mm	1000mm						
							TW / Clay	Concrete	TW / Clay	Concrete	TW / Clay	Concrete
	mm	mm	kg	kg	kg	kg	mm	mm	mm	mm	mm	mm
N27A	1300	800	3990	6270	7410	8550	750	825	750	675	600	600
N27B	1450	950	4305	6585	7725	8865	900	900	900	825	750	750
N27C	1600	1100	4620	6900	8040	9180	1050	1050	1050	900	900	900
N27D	1750	1250	4935	7215	8355	9495	1200	1200	1200	1050	1050	1050
N27E	1900	1400	5255	7535	8675	9815	1200	1350	1200	1200	1200	1050

Installation Guidelines

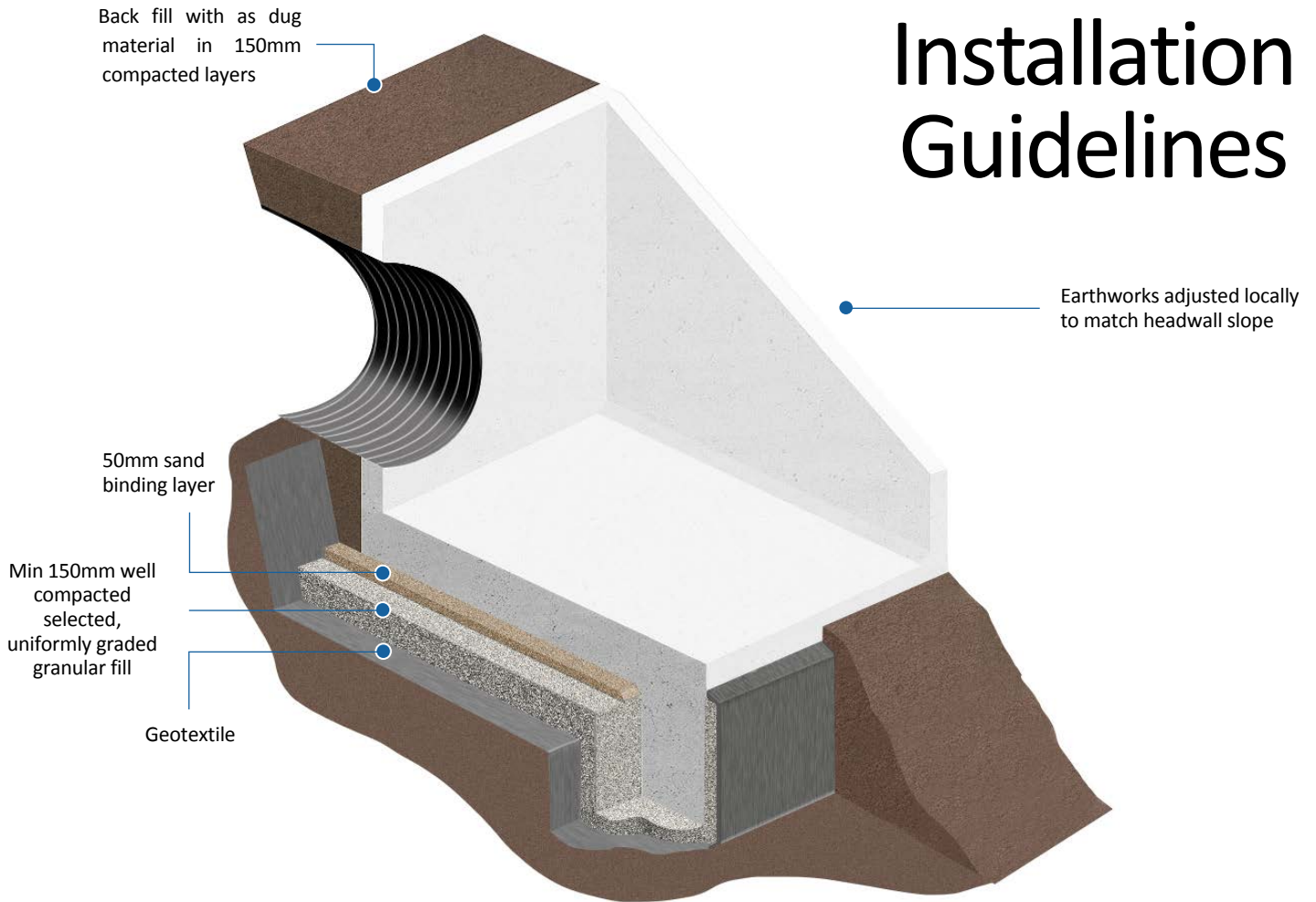

- 1 Ensure that first or last spigot/butt or socket/butt pipe that is to be fitted to the Headwall is in position and free from backfill.
- 2 Dig out the bank of the watercourse to take the size of the headwall making sure that the Headwall will not protrude into the path of the water flow. The angle of the excavation to the rear of the Headwall should be roughly the same as the existing bank profile.
- 3 Dig out sufficient size trench to take the toe along the front of the foundation.
- 4 Line toe foundation with Geotextile then place selected, uniformly graded granular fill in the base and compact well. Lift Toe into position and level then fill around the toe with selected, uniformly graded granular fill and compact well. Insert supplied threaded rod into the sockets cast into the top of the toe.
- 5 Line the base of the rest of excavation with Geotextile then place a minimum bed of 150mm Class 6A* Selected Well Graded Granular Material on the base & compact well, especially around the back of the toe, then a 50mm blinding layer of sharp sand. Lift Headwall into position, over the end of the pipe & locate over threaded rod protruding from the toe and level. Place washer over threaded rod (SFA10 8 No) in recess in Headwall apron and tighten nut. Fill recess with high strength non-shrink grout.
- 6 The pipe should be flush with the front of the back wall if fitting grating or flap valve, or protruding by 50mm if not.
- 7 Shim the pipe until it is central within the opening then fill void with sand cement mortar or high strength non-shrink grout.
- 8 If flap valve or grating is supplied, this will need to be removed before the pipe is inserted and sealed into place. Then reinstall using stainless steel fixing bolts into cast in sockets. (When bolting flap valves against headwall, use a good quality sealant but do not over tighten bolts or distortion may occur resulting in the valve not seating correctly.
- 9 Backfill pipe section first then backfill all around Headwall with as dug material. Make good at front of toe with as dug material ensuring river bank is returned to its original profile. It may be necessary to provide protection in front of the toe, please refer to engineers' recommendation.

*Manual of Contract Documents for Highway Works: Volume 1 (MCHW1), Specification for Highway Works, Series 600 (Nov 09)

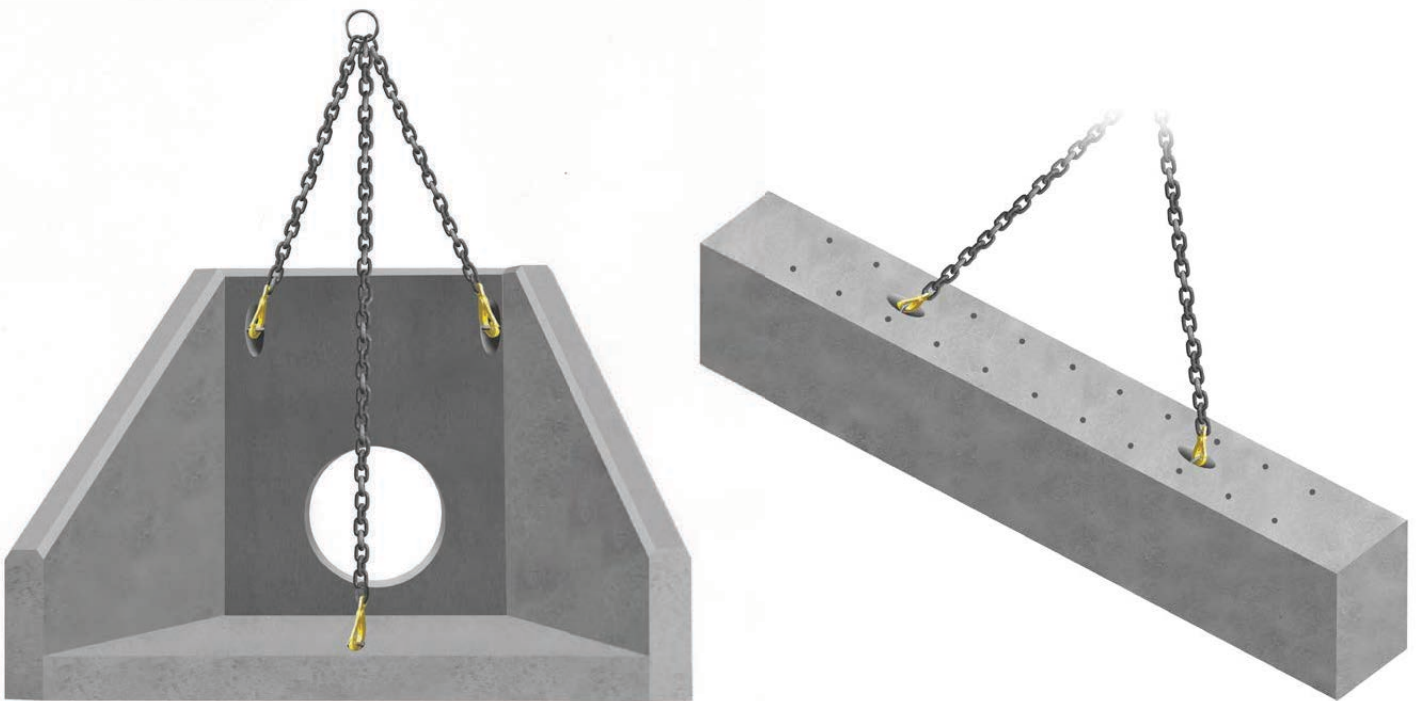

Rapid-Lift Lifting Anchors

All Althon N Headwalls and Toes are fitted with Rapid-Lift lifting anchors. The Althon Rapid-Lift system allows the N Headwalls & Toes to be offloaded, transported and located in their final position without the need for any specialised lifting equipment. Standard lifting hooks and chains can be used with the three lifting points (two lifting points on Toes). The minimum chain leg length for all units is 1500mm.

Althon Precast Concrete N Headwall Safety Sheet

Althon Limited manufacture pre-cast concrete N Headwalls using :-

6 - 14mm aggregate · 0/4mm Sharp sand · Portland cement BS EN 197-1- Cem 1 52.5 · Cryso Fluid Premia 205 Varit Superplasticiser

When units have been manufactured and cured they are in a chemically inert state. But the following information should be considered.

- It is advisable to wear toe cap safety footwear when handling any concrete products. Please refer to your company Safety Policy for specific details on manual handling.
- When cutting with masonry grinding discs or drilling with masonry drill bits it is necessary to wear eye protection and a dust mask. It is also recommended to wear ear protection during either of these two processes.
- Due to some units having sharp edges it is advisable to wear protective gloves when handling Althon products.
- When fitting or removing some of the larger accessories it is necessary to use a mechanical system to prevent risk of back injury.

Maintenance of N Headwalls

With respect to the maintenance of any exposed surfaces of concrete components, only routine (Annual) cleaning may be necessary with a Power Washer and possibly some mild detergent to any exposed surfaces to maintain appearance; however all sites are unique and environmental impact of cleaning should be taken into account. Where cleaning is required and environmental conditions prevent mild detergent, using clean water and a power washer/stiff brush should suffice. Concrete units are often expected to “weather” and some coverage will help them to blend into their environment.

If damage to the structure of any pre-cast concrete components occurs we recommend their replacement not repair. If there is minor damage to corners during their normal life by grass cutting equipment etc. then repair with an epoxy compound such as ‘Mason Mate 0868PR380 Polyester Resin’.

To dispose of any Pre-Cast concrete components the preferred method is to recycle the material by crushing and grading, but if the quantity is too small to be cost effective then disposal in conventional landfill is acceptable as all the concrete components are inert with regard to having any environmental impact.

Maintenance of Galvanised Grates & Handrails.

Annual/bi-annual visual checks are basic recommendations. If gratings are in a water course subject to a higher level of debris/weed, then more regular checks may be required. Clearing of debris/weeds from the grate will ensure no disruption to the flow, or backing up of the water course. Handrails should also only require a visual inspection – annually or at the same time as the headwall & grates.