

One Piece Heavy Duty Silt Trap Inlet

Up to 600mm Pipework
1425mm - 1730mm Backwall Height

A one piece reinforced concrete unit with hinged grating and generous silt capacity. Manufactured in GRC and provided with a unique anchorage system. A lightweight recessed headwall suitable for most situations where batter angle is not less than 45 degrees and for use in minor water courses with moderate flows.

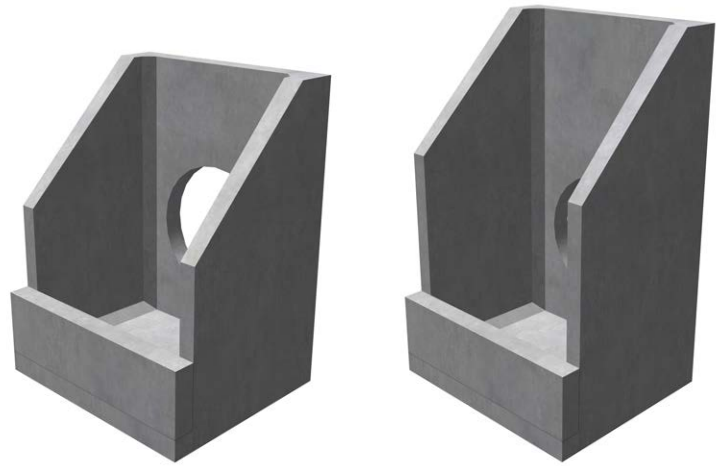

One Piece Heavy Duty Silt Trap Inlet A

One Piece Heavy Duty Silt Trap Inlet B

Optional Kee Klamp handrail

Headwall	Max Pipe Opening Plastic/C/ware	Max Pipe Opening Concrete	A	B	C Min*	D	Approx Weight kg
1PHDST A	600	525	1065	915	400	1425	1250
1PHDST B	600	525	1065	915	400	1730	1450

* Can be increased in 150mm increments to a maximum of 850mm

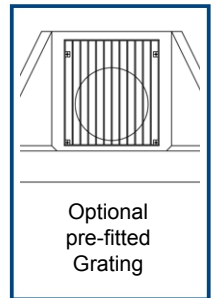
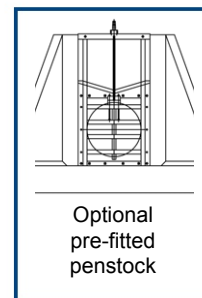
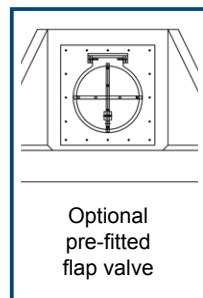
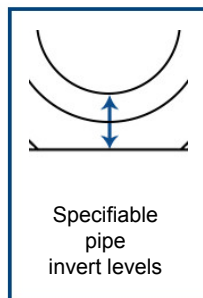
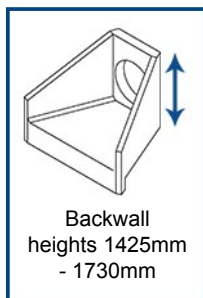
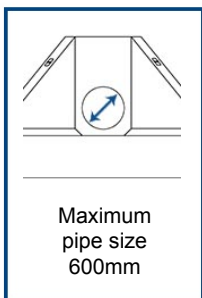
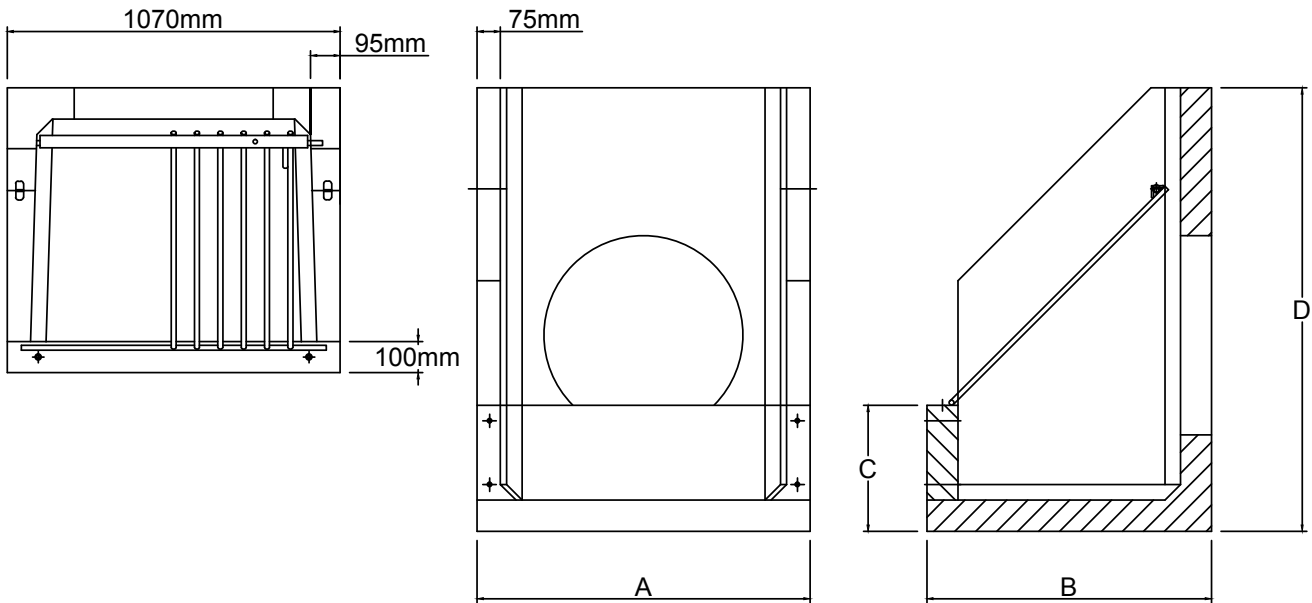



Installation Guide

Once installed correctly the ground pressure of a headwall is low (approximately 13.5kn/m²) Althon suggest a minimum sub base of 200mm dry mix concrete to give a flat and level foundation to sit the headwall onto. The sub base must extend a minimum of 800mm in front of the headwall when at the head of a culvert and 300mm behind to give a total depth of footing of 2 meters to the appropriate width of the headwall.

1. Ensure that the pipe is fully fitted leaving either the first (or last) section of pipe free from backfill in order to attach to the headwall
2. Dig out the bank of the watercourse to take the size of the headwall making sure that the headwall will not protrude into the path of the water flow
3. Lay a minimum (dependant on ground conditions) of 200mm thick bed of dry mix concrete as a flat and level foundation to rest the headwall on
4. Prior to lifting and positioning the headwall attachments such as gratings and water control gear should be removed
5. Lift the headwall into position using 2no RD20 Premium swivel lifting eye's, long chains (minimum of 2000mm long) and suitable machinery. Before carrying out the lifting operation all relevant personnel involved should read the installation and lifting guide in this document and a detailed lift plan and risk assessment should be completed by a competent person
 - The RD20 threaded sockets for lifting are located in the top of the wing-wall
 - Placing a shim at the bottom of the pipe will assist with centring it in position
 - If attachments such as water control gear or gratings are to be fitted to the headwall – the pipe must be fitted flush with the inside of the back wall
 - If there are no attachments to be fitted Althon recommend fitting the headwall so that the pipe protrudes 50mm through the back wall
6. When satisfied with the position backfill in front and around the base of the headwall with mass concrete
7. Backfill around the pipe with either mass concrete or well-compacted impervious clay. If concrete has been used around the pipe then proceed with soil backfilling to the top level of the structure ensuring good compaction as you go
8. Use an appropriate mortar or resin to fill in the gap between the pipe and headwall around the opening in the back wall of the headwall



9. For fitting gratings, catwalks and other fabricated metal components:-

- Fit the sloped hinged grating by resting the plain end on the sill and aligning the two lock bolts with the holes in the side walls, then extend each bolt into these holes. If extra security is needed then either m12 bolts or a padlock can be fitted to the holes in the top edge angle iron thus preventing movement of the lock bolts
- To prevent bolts binding in threaded fixing sockets copper slip must be applied to the thread of all bolts
- Do not exceed a torque setting of 40Nmm² when tightening bolts

10. For fitting water control gear (i.e. Flap Vales & Penstocks):-

- Apply foam seal or mastic sealant to the back plate of the water control gear to ensure a watertight seal between the headwall
- Position the water control gear using appropriate lifting equipment
- Use the correct size and length of stainless steel bolts with washers to fix control gear to the threaded fixing sockets cast into headwalls
- To prevent bolts binding in threaded fixing sockets copper slip must be applied to the thread of all bolts
- Do not exceed a torque setting of 40Nmm² when tightening bolts. Over tightening bolts may distort the back-plate thus preventing the valve from sealing correctly

PLEASE NOTE: After Installation is complete there will be a significant build-up of silt within the first few months due to the disturbance of the watercourse created during installation. The silt chamber must be inspected frequently and cleaned as required within the first year of installation and subsequently less often. This is non-specific as the rate with which the silt builds up is dependent on surrounding soil types and total catchment area.