

# R18B Left Hand Angled Headwall Range

Up to 825mm Pipework  
1300mm Backwall Height

300 and 500mm Thick Toe

Althon R18 Rectangular Angled Precast Headwalls are for outfalls discharging into ponds, swales, ditches beaches and rivers. Rectangular precast headwalls come with the option of two thicknesses of toe, 300mm and 500mm, each of which is available in three depths.

Althon manufacture R18 precast headwalls with three different wall profiles to suit the gradient of the bank as follows 1 : 1 slope, 1 : 2 slope and 1 : 3 slope.

All Rectangular Headwalls are cast with the opening in the back wall to suit the size and type of pipe being used at the invert level required.



R18B 01 2270 LH  
1:1 Wing Wall  
1 Piece Headwall



R18B 01 2790 LH  
1:1 Wing Wall  
2 Piece Headwall



R18B 05 2940 LH  
1:2 Wing Wall  
2 Piece Headwall



R18B 10 3570 LH  
1:3 Wing Wall  
2 Piece Headwall

Optional Kee Klamp handrail

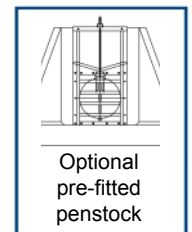
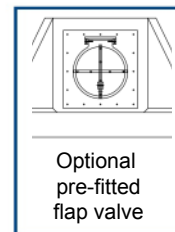
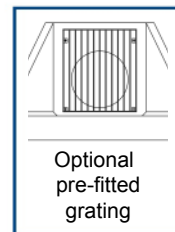
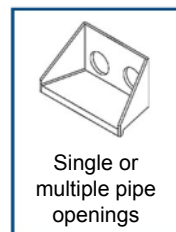
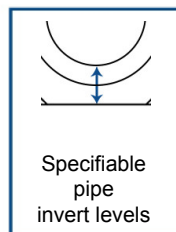
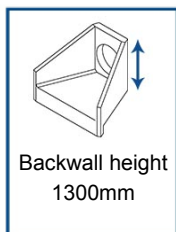
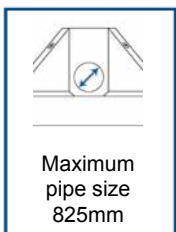
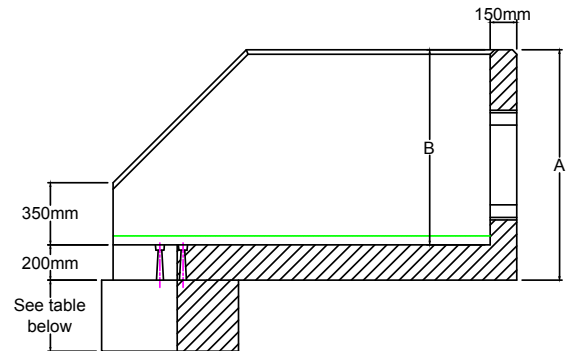
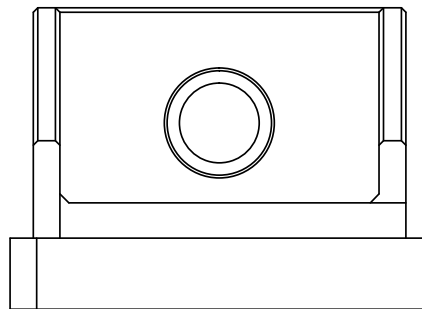
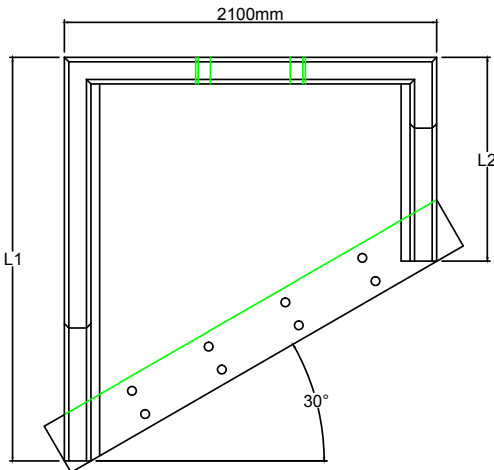

# R18B Left Hand Angled Headwall Range

Up to 825mm Pipework  
1300mm Backwall Height

300mm Thick Toe

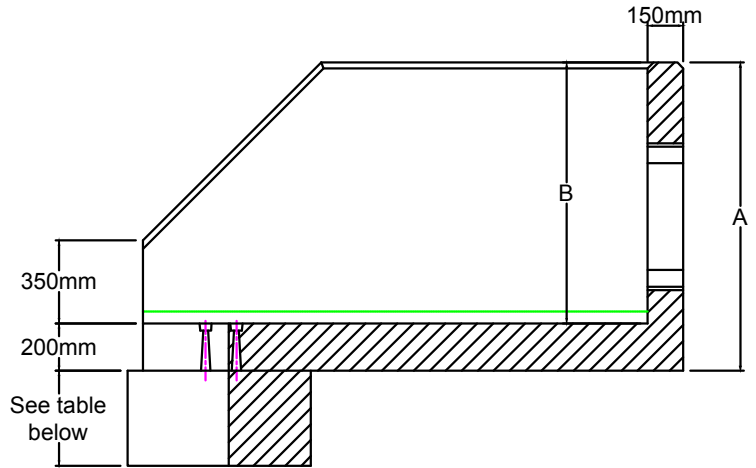

Headwall Ref	Back Wall Height A	Back Wall Height B	Length L1	Length L2	Wing Wall Profile	Weight	Weight with Toe			Max Pipe Opening	Max Pipe Opening	Max Pipe Opening	Max Pipe Opening	Max Pipe Opening	Max Pipe Opening
							400mm	650mm	950mm						
										Invert Level with Apron	100mm Invert Level		225mm Invert Level		
										TW / Clay	Concrete	TW / Clay	Concrete	TW / Clay	Concrete
	mm	mm	mm	mm		kg	kg	kg	kg	mm	mm	mm	mm	mm	mm
R18B 01 2270 LH	1300	1100	2276	1150	1:1	3620	4370	4830	5390	750	825	750	750	600	600
R18B 01 2790 LH	1300	1100	2796	1670	1:1	4500	5250	5710	6270	750	825	750	750	600	600
R18B 05 2940 LH	1300	1100	2946	1820	1:2	4600	5350	5810	6370	750	825	750	750	600	600
R18B 10 3570 LH	1300	1100	3576	2450	1:3	5580	6330	6790	7350	750	825	750	750	600	600

## 500mm Thick Toe

Headwall Ref	Back Wall Height A	Back Wall Height B	Length L1	Length L2	Wing Wall Profile	Weight	Weight with Toe			Max Pipe Opening	Max Pipe Opening	Max Pipe Opening	Max Pipe Opening	Max Pipe Opening	Max Pipe Opening
							500mm	750mm	1000mm						
										Invert Level with Apron	100mm Invert Level		225mm Invert Level		
										TW / Clay	Concrete	TW / Clay	Concrete	TW / Clay	Concrete
	mm	mm	mm	mm		kg	kg	kg	kg	mm	mm	mm	mm	mm	mm
R18B 01 2270 LH	1300	1100	2276	1150	1:1	3620	5240	6050	6860	750	825	750	750	600	600
R18B 01 2790 LH	1300	1100	2796	1670	1:1	4500	6120	6930	7740	750	825	750	750	600	600
R18B 05 2940 LH	1300	1100	2946	1820	1:2	4600	6220	7030	7840	750	825	750	750	600	600
R18B 10 3570 LH	1300	1100	3576	2450	1:3	5580	7200	8010	8820	750	825	750	750	600	600

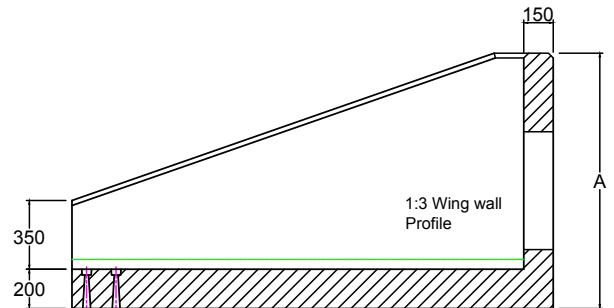
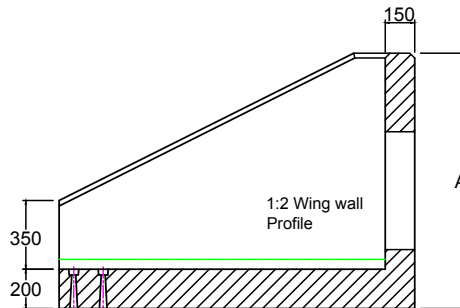
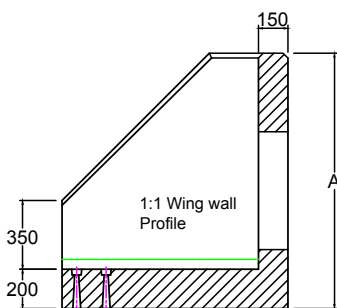

# Installation Guidelines

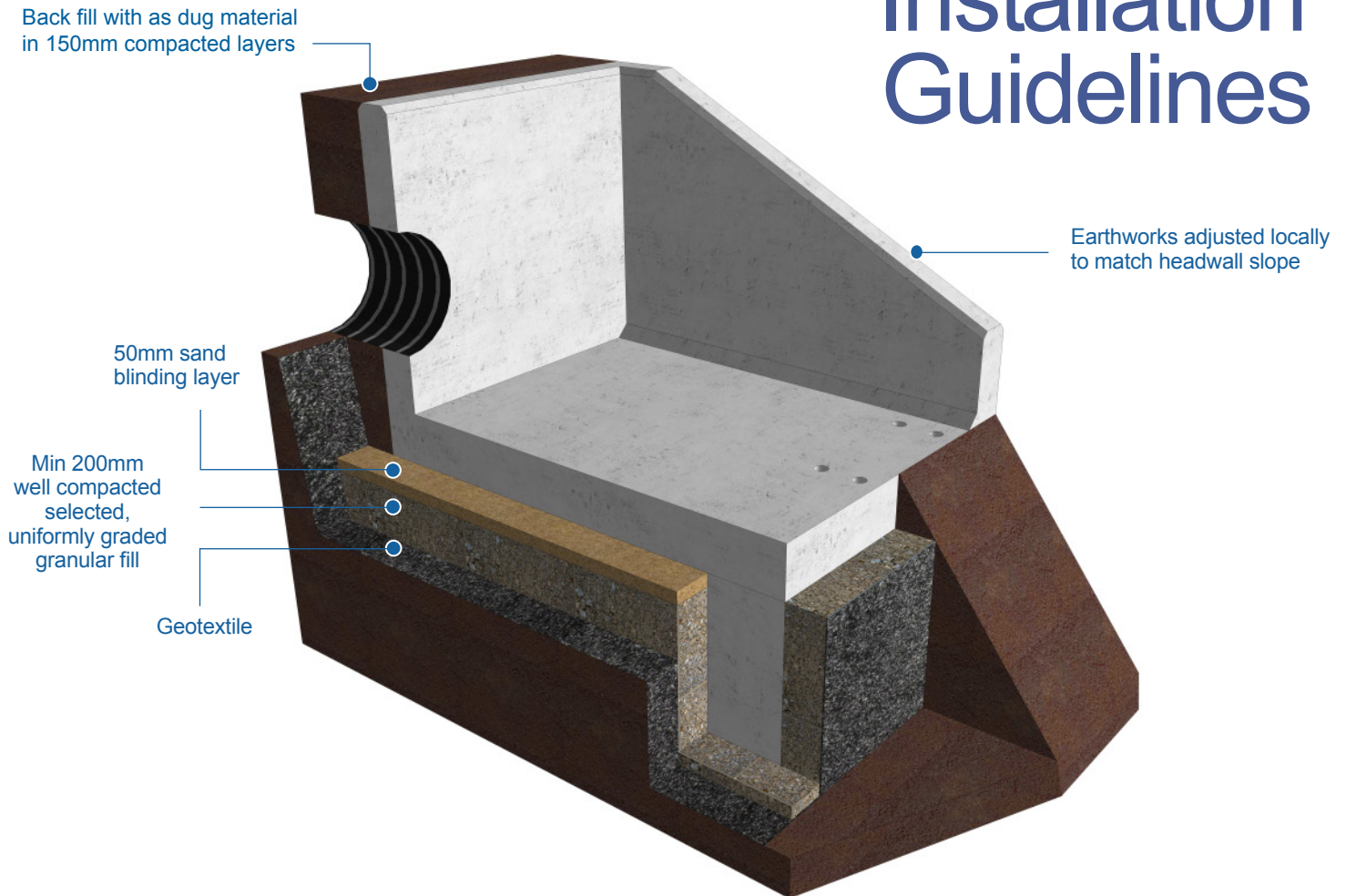

- 1 Ensure that first or last spigot/butt or socket/butt pipe that is to be fitted to the Headwall is in position and free from backfill.
- 2 Dig out the bank of the watercourse to take the size of the headwall making sure that the Headwall will not protrude into the path of the water flow. The angle of the excavation to the rear of the Headwall should be roughly the same as the existing bank profile.
- 3 Dig out sufficient size trench to take the toe along the front of the foundation.
- 4 Line toe foundation with Geotextile then place selected, uniformly graded granular fill in the base and compact well. Lift Toe into position and level then fill around the toe with selected, uniformly graded granular fill and compact well. Insert supplied threaded rod into the sockets cast into the top of the toe.
- 5 Line the base of the rest of excavation with Geotextile then place a minimum bed of 200mm Class 6A\* Selected Well Graded Granular Material on the base & compact well, especially around the back of the toe, then a 50mm blinding layer of sharp sand. Lift Headwall into position, over the end of the pipe & locate over threaded rod protruding from the toe and level. Place washer over threaded rod in recess in Headwall apron and tighten nut. Fill recess with high strength non-shrink grout.
- 6 The pipe should be flush with the front of the back wall if fitting grating or flap valve, or protruding by 50mm if not.
- 7 Shim the pipe until it is central within the opening then fill void with sand cement mortar or high strength non-shrink grout.
- 8 If flap valve or grating is supplied, this will need to be removed before the pipe is inserted and sealed into place. Then reinstall using stainless steel fixing bolts into cast in sockets. (When bolting flap valves against headwall, use a good quality sealant but do not over tighten bolts or distortion may occur resulting in the valve not seating correctly.
- 9 Backfill pipe section first then backfill all around Headwall with as dug material. Make good at front of toe with as dug material ensuring river bank is returned to its original profile. It may be necessary to provide protection in front of the toe, please refer to engineers' recommendation

\*Manual of Contract Documents for Highway Works: Volume 1 (MCHW1), Specification for Highway Works, Series 600 (Nov 09)

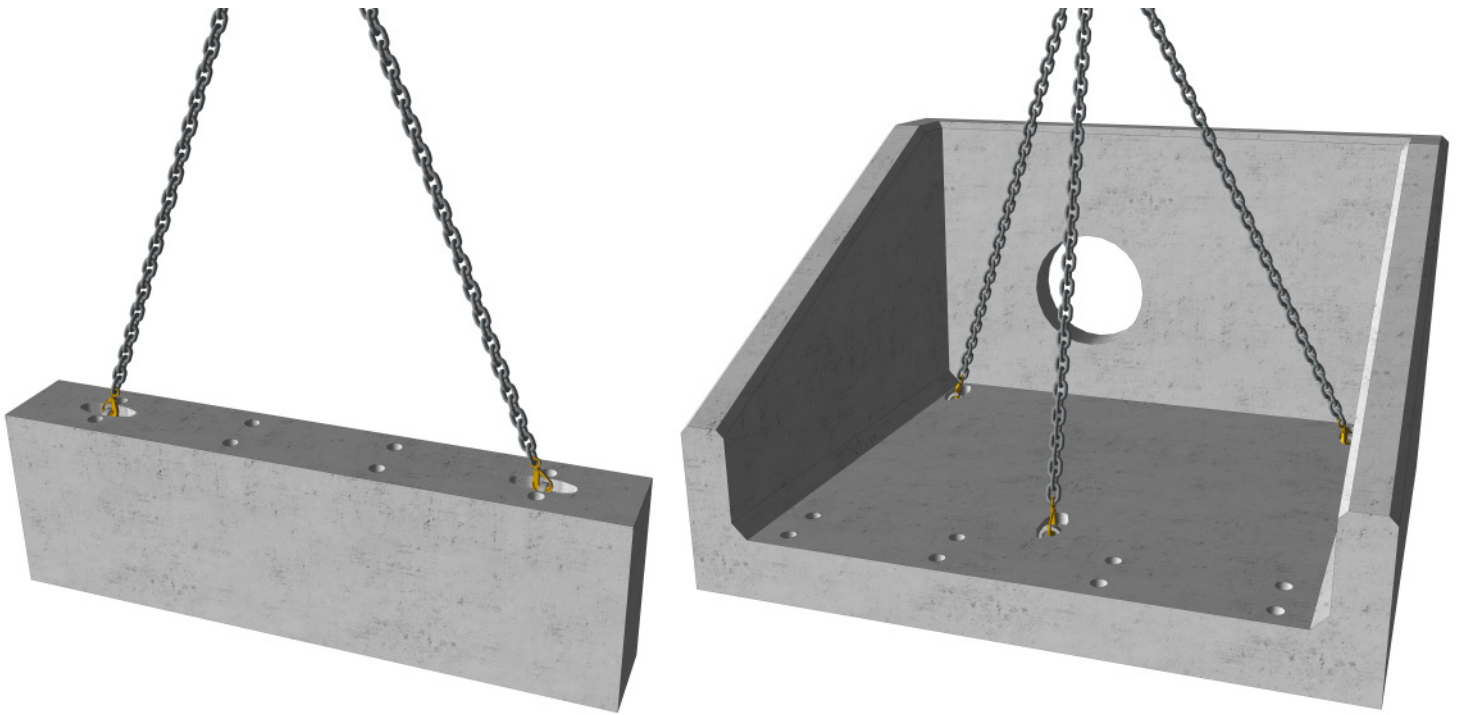

## Rapid-Lift Lifting Anchors

All Althon R Headwalls and Toes are fitted with Rapid-Lift lifting anchors. The Althon Rapid-Lift system allows the R Headwalls & Toes to be offloaded, transported and located in their final position without the need for any specialised lifting equipment. Standard lifting hooks and chains can be used with the three lifting points (two lifting points on Toes). The minimum chain leg length for all units is 1500mm.

## Althon Precast Concrete R Headwall Safety Sheet

Althon Limited manufacture pre-cast concrete R Headwalls using :-

**6 - 14mm aggregate · 0/4mm Sharp sand · Portland cement BS EN 197-1- Cem 1 52.5 · Cryso Fluid Premia 205 Varit Superplasticiser** When units have been manufactured and cured they are in a chemically inert state. But the following information should be considered.

- It is advisable to wear toe cap safety footwear when handling any concrete products. Please refer to your company Safety Policy for specific details on manual handling.
- When cutting with masonry grinding discs or drilling with masonry drill bits it is necessary to wear eye protection and a dust mask. It is also recommended to wear ear protection during either of these two processes.
- Due to some units having sharp edges it is advisable to wear protective gloves when handling Althon products.
- When fitting or removing some of the larger accessories it is necessary to use a mechanical system to prevent risk of back injury.

## Maintenance of R Headwalls

With respect to the maintenance of any exposed surfaces of concrete components, only routine (Annual) cleaning may be necessary with a Power Washer and possibly some mild detergent to any exposed surfaces to maintain appearance; however all sites are unique and environmental impact of cleaning should be taken into account. Where cleaning is required and environmental conditions prevent mild detergent, using clean water and a power washer/stiff brush should suffice. Concrete units are often expected to “weather” and some coverage will help them to blend into their environment.

If damage to the structure of any pre-cast concrete components occurs we recommend their replacement not repair. If there is minor damage to corners during their normal life by grass cutting equipment etc. then repair with an epoxy compound such as ‘Mason Mate 0868PR380 Polyester Resin’.

To dispose of any Pre-Cast concrete components the preferred method is to recycle the material by crushing and grading, but if the quantity is too small to be cost effective then disposal in conventional landfill is acceptable as all the concrete components are inert with regard to having any environmental impact.

### Maintenance of Galvanised Grates & Handrails.

Annual/bi-annual visual checks are basic recommendations. If gratings are in a water course subject to a higher level of debris/weed, then more regular checks may be required. Clearing of debris/weeds from the grate will ensure no disruption to the flow, or backing up of the water course. Handrails should also only require a visual inspection – annually or at the same time as the headwall & grates.