



# RSFA18A Left Hand Angled Headwall Range

Up to 450mm Pipework  
1080mm Backwall Height

300 and 500mm Thick Toe

The RSFA18A Headwalls are a single piece structure with a wing wall profile of 1:1, 1:2 or 1:3 an internal back wall height of 880mm, suitable for pipes with a maximum internal diameter of 450mm and supplied with a separate toe beam.

Sewers for Adoption Guidelines call for an Outfall Safety Grille to be fitted to all openings 350mm and above. The RSFA18A back wall allows room for an SFA Compliant Outfall Safety Grille to be fitted along with an access ladder, Kee Klamp® Size 8 GMS Handrail is also fitted to the back wall and the horizontal section of the wing walls with a self-closing gate above the access ladder.

The RSFA18A Headwalls are available in one length; there are two thicknesses of toe beam available each in three depths to suit site conditions. The RSFA18A Headwalls are in accordance with Severn Trent Water Drawing No STD6002 Rev 02



RSFA18A 01 2270 LH  
1:1 Wing Wall



RSFA18A 01 2940 LH  
1:1 Wing Wall



RSFA18A 05 2940 LH  
1:2 Wing Wall



RSFA18A 05 3210 LH  
1:2 Wing Wall



RSFA18A 10 3570 LH  
1:3 Wing Wall

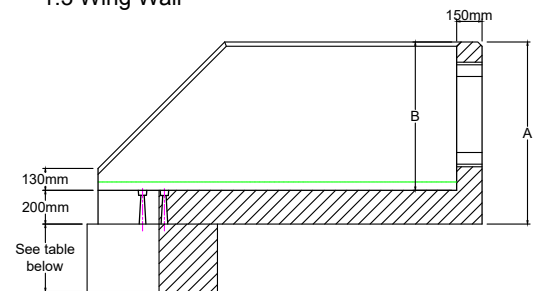
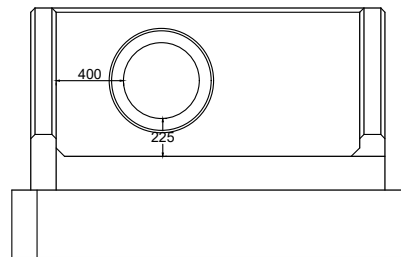
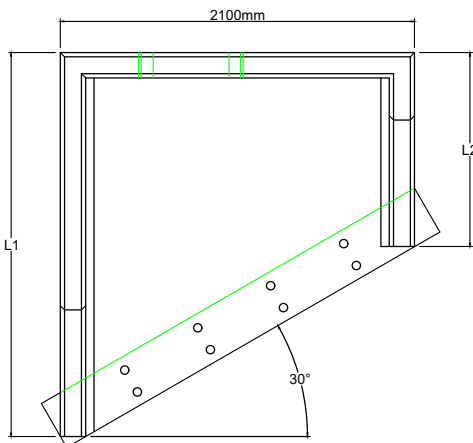

Maximum pipe size 450mm

Backwall height 1080mm

Specifiable pipe invert levels

Single or multiple pipe openings

Optional pre-fitted grating

Optional pre-fitted flap valve

Optional pre-fitted penstock

# RSFA18A Left Hand Angled Headwall Range

Up to 450mm Pipework  
1080mm Backwall Height

300mm Thick Toe

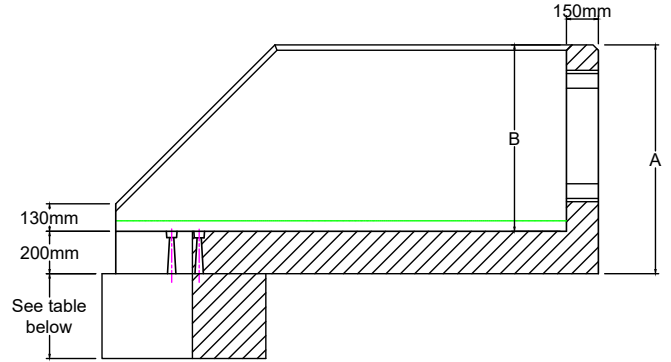

Headwall Ref	Back Wall Height A	Back Wall Height B	Length L1	Length L2	Wing Wall Profile	Weight	Weight with Toe			Max Pipe Opening	Max Pipe Opening	Max Pipe Opening	Max Pipe Opening	Available with Baffle Blocks
							400mm	650mm	950mm					
							With SFA Grating				Without Grating			
							TW / Clay		Concrete		TW / Clay	Concrete		
							mm	mm	mm	mm	mm	mm	mm	
RSFA18A 01 2270 LH	1080	880	2276	1150	1:1	3210	3960	4420	4980	450	450	450	450	No
RSFA18A 01 2940 LH	1080	880	2946	1820	1:1	4290	5040	5500	6060	450	450	450	450	Yes
RSFA18A 05 2940 LH	1080	880	2946	1820	1:2	4080	4830	5290	5850	450	450	450	450	No
RSFA18A 05 3210 LH	1080	880	3216	2090	1:2	4500	5250	5710	6270	450	450	450	450	Yes
RSFA18A 10 3570 LH	1080	880	3576	2450	1:3	4950	5700	6160	6720	450	450	450	450	Yes

500mm Thick Toe

Headwall Ref	Back Wall Height A	Back Wall Height B	Length L1	Length L2	Wing Wall Profile	Weight	Weight with Toe			Max Pipe Opening	Max Pipe Opening	Max Pipe Opening	Max Pipe Opening	Available with Baffle Blocks
							500mm	750mm	1000mm					
							With SFA Grating				Without Grating			
							TW / Clay		Concrete		TW / Clay	Concrete		
							mm	mm	mm	mm	mm	mm	mm	
RSFA18A 01 2270 LH	1080	880	2276	1150	1:1	3210	4830	5640	6450	450	450	450	450	No
RSFA18A 01 2940 LH	1080	880	2946	1820	1:1	4290	5910	6720	7530	450	450	450	450	Yes
RSFA18A 05 2940 LH	1080	880	2946	1820	1:2	4080	5700	6510	7320	450	450	450	450	No
RSFA18A 05 3210 LH	1080	880	3216	2090	1:2	4500	6120	6930	7740	450	450	450	450	Yes
RSFA18A 10 3570 LH	1080	880	3576	2450	1:3	4950	6570	7380	8190	450	450	450	450	Yes

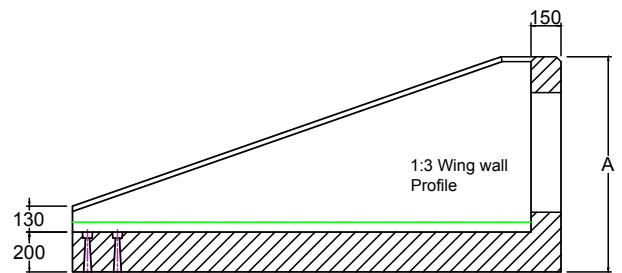
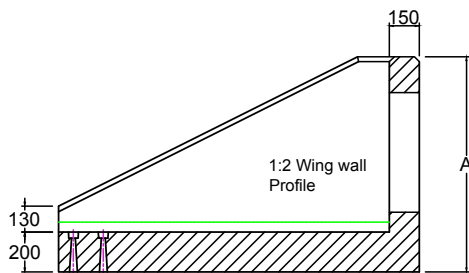
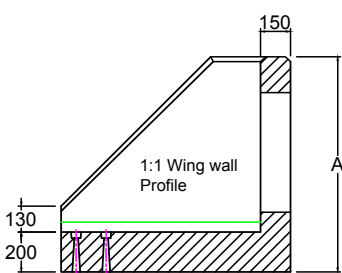

# Installation Guidelines

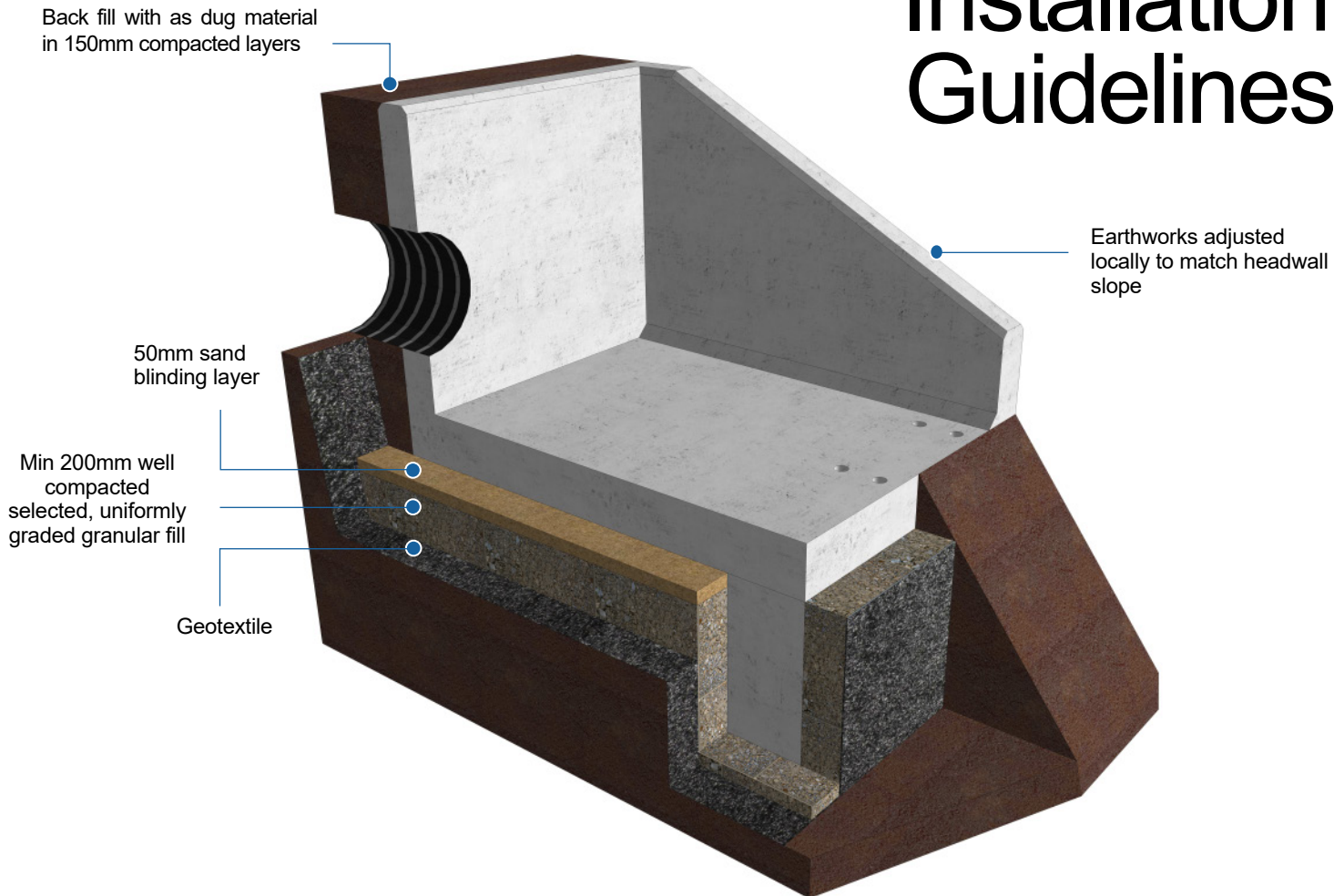

- 1 Ensure that first or last spigot/butt or socket/butt pipe that is to be fitted to the Headwall is in position and free from backfill.
- 2 Dig out the bank of the watercourse to take the size of the headwall making sure that the Headwall will not protrude into the path of the water flow. The angle of the excavation to the rear of the Headwall should be roughly the same as the existing bank profile.
- 3 Dig out sufficient size trench to take the toe along the front of the foundation.
- 4 Line toe foundation with Geotextile then place selected, uniformly graded granular fill in the base and compact well. Lift Toe into position and level then fill around the toe with selected, uniformly graded granular fill and compact well. Insert supplied threaded rod into the sockets cast into the top of the toe.
- 5 Line the base of the rest of excavation with Geotextile then place a minimum bed of 200mm Class 6A\* Selected Well Graded Granular Material on the base & compact well, especially around the back of the toe, then a 50mm blinding layer of sharp sand. Lift Headwall into position, over the end of the pipe & locate over threaded rod protruding from the toe and level. Place washer over threaded rod in recess in Headwall apron and tighten nut. Fill recess with high strength non-shrink grout.
- 6 The pipe should be flush with the front of the back wall if fitting grating or flap valve, or protruding by 50mm if not.
- 7 Shim the pipe until it is central within the opening then fill void with sand cement mortar or high strength non-shrink grout.
- 8 If flap valve or grating is supplied, this will need to be removed before the pipe is inserted and sealed into place. Then reinstall using stainless steel fixing bolts into cast in sockets. (When bolting flap valves against headwall, use a good quality sealant but do not over tighten bolts or distortion may occur resulting in the valve not seating correctly.
- 9 Backfill pipe section first then backfill all around Headwall with as dug material. Make good at front of toe with as dug material ensuring river bank is returned to its original profile. It may be necessary to provide protection in front of the toe, please refer to engineers' recommendation

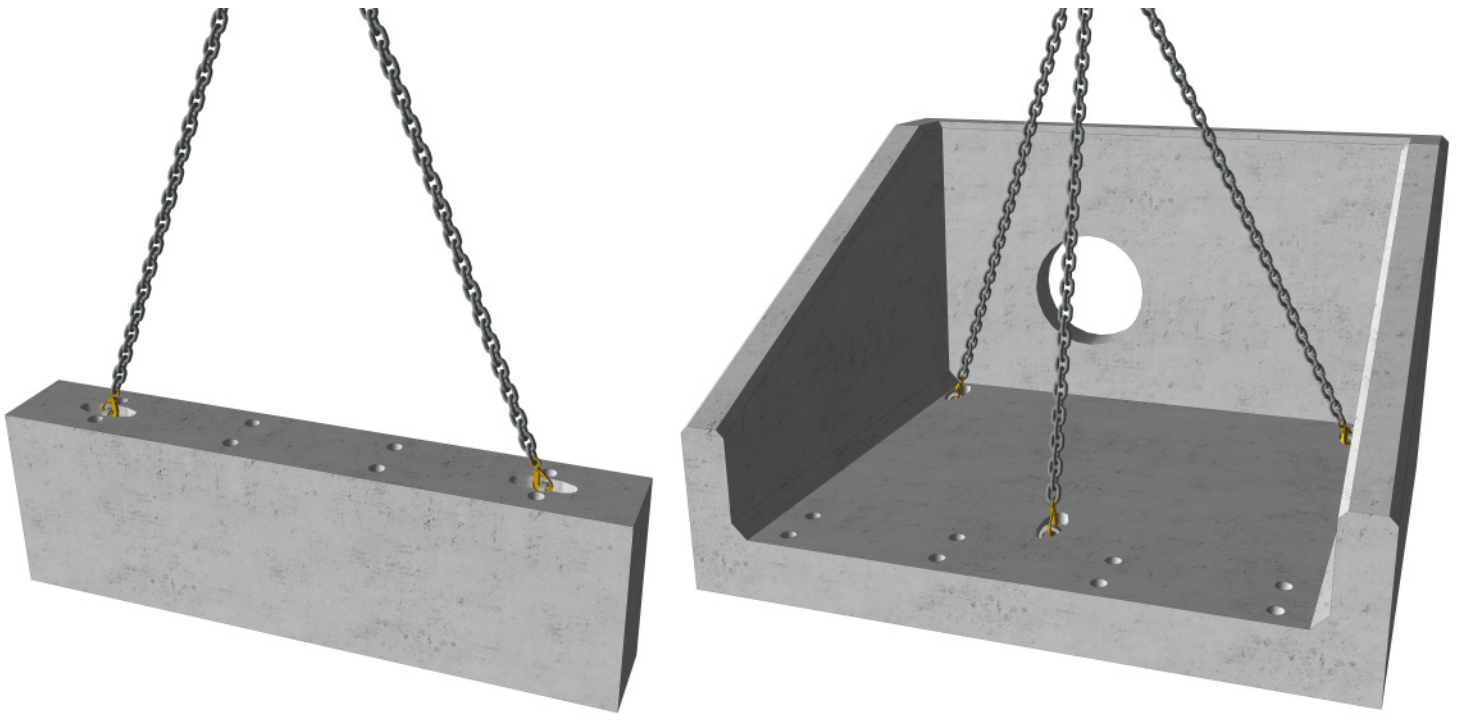

## Rapid-Lift Lifting Anchors

All Althon R Headwalls and Toes are fitted with Rapid-Lift lifting anchors. The Althon Rapid-Lift system allows the R Headwalls & Toes to be offloaded, transported and located in their final position without the need for any specialised lifting equipment. Standard lifting hooks and chains can be used with the three lifting points (two lifting points on Toes). The minimum chain leg length for all units is 1500mm.

## Althon Precast Concrete R Headwall Safety Sheet

Althon Limited manufacture pre-cast concrete R Headwalls using :-

**6 - 14mm aggregate · 0/4mm Sharp sand · Portland cement BS EN 197-1- Cem 1 52.5 · Cryso Fluid Premia 205 Varit Superplasticiser** When units have been manufactured and cured they are in a chemically inert state. But the following information should be considered.

- It is advisable to wear toe cap safety footwear when handling any concrete products. Please refer to your company Safety Policy for specific details on manual handling.
- When cutting with masonry grinding discs or drilling with masonry drill bits it is necessary to wear eye protection and a dust mask. It is also recommended to wear ear protection during either of these two processes.
- Due to some units having sharp edges it is advisable to wear protective gloves when handling Althon products.
- When fitting or removing some of the larger accessories it is necessary to use a mechanical system to prevent risk of back injury.

## Maintenance of R Headwalls

With respect to the maintenance of any exposed surfaces of concrete components, only routine (Annual) cleaning may be necessary with a Power Washer and possibly some mild detergent to any exposed surfaces to maintain appearance; however all sites are unique and environmental impact of cleaning should be taken into account. Where cleaning is required and environmental conditions prevent mild detergent, using clean water and a power washer/stiff brush should suffice. Concrete units are often expected to "weather" and some coverage will help them to blend into their environment.

If damage to the structure of any pre-cast concrete components occurs we recommend their replacement not repair. If there is minor damage to corners during their normal life by grass cutting equipment etc. then repair with an epoxy compound such as 'Mason Mate 0868PR380 Polyester Resin'.

To dispose of any Pre-Cast concrete components the preferred method is to recycle the material by crushing and grading, but if the quantity is too small to be cost effective then disposal in conventional landfill is acceptable as all the concrete components are inert with regard to having any environmental impact.

### Maintenance of Galvanised Grates & Handrails.

Annual/bi-annual visual checks are basic recommendations. If gratings are in a water course subject to a higher level of debris/weed, then more regular checks may be required. Clearing of debris/weeds from the grate will ensure no disruption to the flow, or backing up of the water course. Handrails should also only require a visual inspection – annually or at the same time as the headwall & grates.